



HPF FILTERS

USER MANUAL

INTERNATIONAL CAPACITORS S.A.

TABLE OF CONTENTS

TABLE OF CONTENTS	2
1 CHECKS ON RECEIPT OF THE EQUIPMENT.	3
2 INTRODUCTION.	3
3 OPERATING PRINCIPLE.	3
3.1 HOW TO SELECT A HPF FILTER?	3
4 TECHNICAL CHARACTERISTICS	4
4.1 GENERAL.	4
4.2 REACTORS	4
4.3 CAPACITORS	5
4.4 STANDARD TYPES (THREE PHASE 50Hz)	5
4.5 OVERCOMPENSATION RELAY OPTION	5
4.6 DIMENSIONS	6
4.7 SCHEMATICS	7
5 INSTALLATION AND START-UP.	8
5.1 LOCATION	8
5.2 INITIAL CHECKS (PRE-INSTALLATION, SWITCH THE POWER OFF).	8
5.3 POWER CIRCUIT CONNECTION	8
5.4 OPERATING CIRCUIT CONNECTION (ONLY IN CASE OF OVERCOMPENSATION PROTECTION)	8
5.5 START-UP	8
6 CHECK POINTS	8
7 PERIODICAL SERVICING	9
8 SAFETY	9
9 TECHNICAL SERVICE AND GUARANTEE	9

1 CHECKS ON RECEIPT OF THE EQUIPMENT.

Before installing and handling the equipment check that:

- 1) The equipment has not been damaged during delivery.
- 2) The equipment supplied is suitable for your requirements and is the type you ordered.
- 3) The operating voltage of the equipment supplied is suitable for your requirements.
- 4) Manuals for the equipment and for the regulator are supplied with the capacitor bank.
- 5) If any problem is noticed, please contact the commercial service department of INTERNATIONAL CAPACITOR S.A.

2 INTRODUCTION.

HPF filters are specially designed to reduce harmonics of current absorbed by power converters, with a rectifier input stage. (Frequency converters for motors, UPS, etc.). Mainly, they are made of a parallel-series combination of reactors and capacitors adapted to reduce the THD(I) of rectifiers. They are specially designed to reduce the THD(I) to values of approximately 8%, in order to comply with IEC-61000-3.4 and IEEE-519 standards.

3 OPERATING PRINCIPLE.

The structure of HPF filters is as shown in the schematics below. The basic filter is designed with L1,L2, L3 and C. In some cases reactor L4, is already placed in front of the converter. In such case L2 may be unnecessary

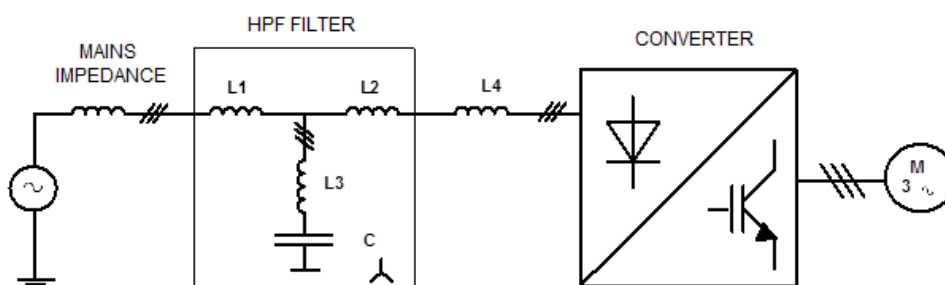

Fig. 1.- HPF filters Structure

3.1 How to select a HPF filter?

HPF filters must be selected according to the current absorbed by the converter. In case of converters with very low power rating, a unique HPF filter may be used to supply several converters, but only in case the all start and stop at the same time. If several converters starting and stopping separately are supplied by the same HPF filter, the system is not effective on filtering the harmonics. In such case an individual HPF should be used for each converter.

ATTENTION: HPF filters may produce $\cos\phi$ overcompensation in case that the converter is absorbing a current much lower than the rated current of the filter itself. This can be avoided by disconnecting the parallel LC circuit when the current falls below a certain adjustable limit. An optional protection circuit, consisting of a CMM-96-MD and a contactor, may be added to perform this function, if requested in the order.

WARNING!!!: Due to the HPF filter performance mode, it is quite likely to find elevated harmonic distortion levels of voltage at the input of the speed drive (downstream to the filter output reactor (L2)). This voltage distortion should cause no malfunction of the speed drive to be filtered, but it is very much recommendable, in case that this power drive is taken the auxiliary voltage supply of the control system from the input of the drive, to take this auxiliary supply from the HPF input, that is, upstream to the filter input reactor (L1).

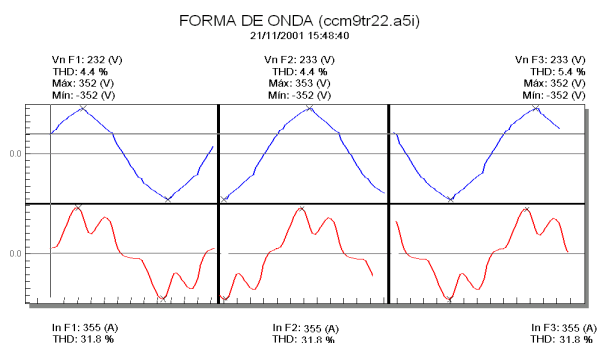

Fig. 2.a. Mains supply without HPF filter

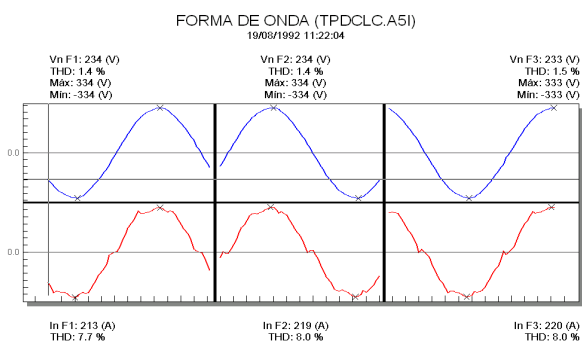

Fig. 2.b. Mains supply without HPF filter

4 TECHNICAL CHARACTERISTICS

4.1 General.

Standard voltage (phase to phase)	400V (Others on request)
Frequency	50Hz for types HPF -35-xx or 60 Hz for types HPF -36-xx
Rated load current	See table of types
Rated filtering current	See table of types
Parallel filter protection	Fuses NH or NZ type depending on size
Residual THD	Aprox. 8%
Voltage drop at rated current	< 2%
Standards	EN 60439, EN 60831 ; EN-50081-1, EN-50081-2 , class A
Ambient temperature	Ambient : 40°C
Relative Humidity	80%

4.2 Reactors

Core / Coil	High permeability metal sheet / Aluminium
Isolation voltage	2kV
Tolerance in L value	<3%
Saturation $\Delta L=5\%$	1,6 of rated current
Maximum ambient temperature	60°C
Internal temperature at I_{rated}	<110°C
Protection thermostat trip	90 °C
Total maximum overload $\Sigma(n.I_n)^2$	25%
Permanent	20%
Transient (1 min)	2 I_{rated}

4.3 Capacitors

Dielectric	Polypropylene Self-healing
Working voltage	< 1,15 of rated U
Transient overload (10s)	1000 V
Isolation voltage against earth	3 kV
Operating temperature	-25 / +50 °C
Losses	0,5W/kvar

4.4 Standard Types (Three phase 50Hz)

TYPE (1) (3)	RATED VOLTAGE (V)	RATED LOAD CURRENT (A _{RMS})	RATED FILTERING CURRENT (A _{RMS}) (2)	CABINET MODEL	LOSSES W
HPF 35-9A-400	400/415	9	3,6	A	55
HPF 35-12A-400	400/415	12	4,8	A	73
HPF 35-16A-400	400/415	16	6,4	A	97
HPF 35-22A-400	400/415	22	8,8	A	134
HPF 35-32A-400	400/415	32	12,8	A	194
HPF 35-40A-400	400/415	40	16	A	243
HPF 35-47A-400	400/415	47	18,8	B	286
HPF 35-54A-400	400/415	54	21,6	B	328
HPF 35-64A-400	400/415	64	25,6	B	389
HPF 35-76A-400	400/415	76	30,4	B	462
HPF 35-90A-400	400/415	90	36	B	547
HPF 35-110A-400	400/415	110	44	C	668
HPF 35-150A-400	400/415	150	60	C	911
HPF 35-180A-400	400/415	180	72	C	1094
HPF 35-220A-400	400/415	220	88	D	1337
HPF 35-260A-400	400/415	260	104	D	1580
HPF 35-320A-400	400/415	320	128	D	1944
HPF 35-400A-400	400/415	400	160	D	2430

REMARKS

- 1) If protection against power factor overcompensation is desired, specify in the order
- 2) Load is supposed to be a three phase 6 pulse rectifier, with dominant harmonics of order 5 and 7
- 3) For 60 Hz types, specify HPF 36 instead of HPF 35

4.5 Overcompensation relay option

Measuring instrument	CMM-96-MD
Contacteur	suitable for the filter power
Current transformer	TP type

4.6 DIMENSIONS

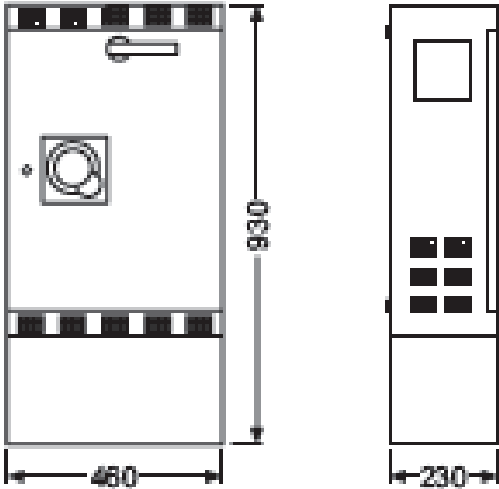

A - Sizes from 9 to 40 A IP21

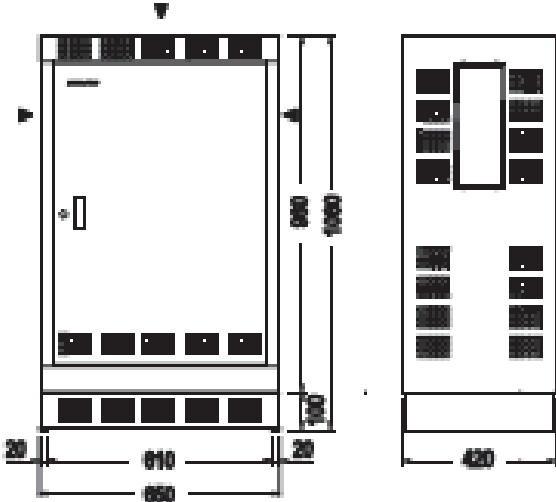

B - Sizes from 47 to 90 A IP21

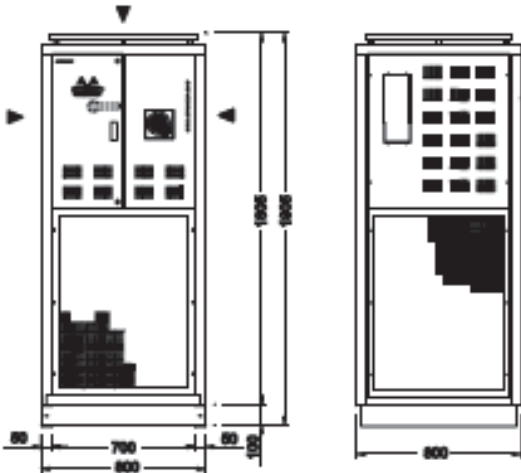

C - Sizes from 110 to 180 A IP21

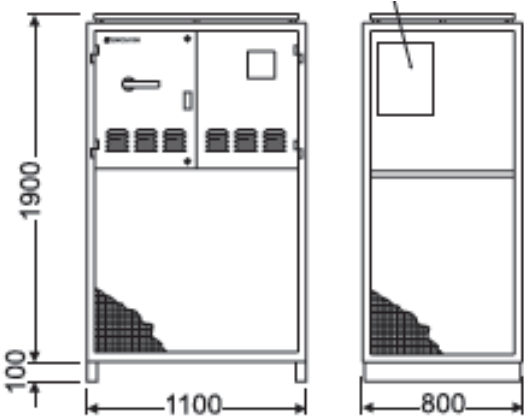

D - Sizes from 220 to 400 A IP21

4.7 SCHEMATICS

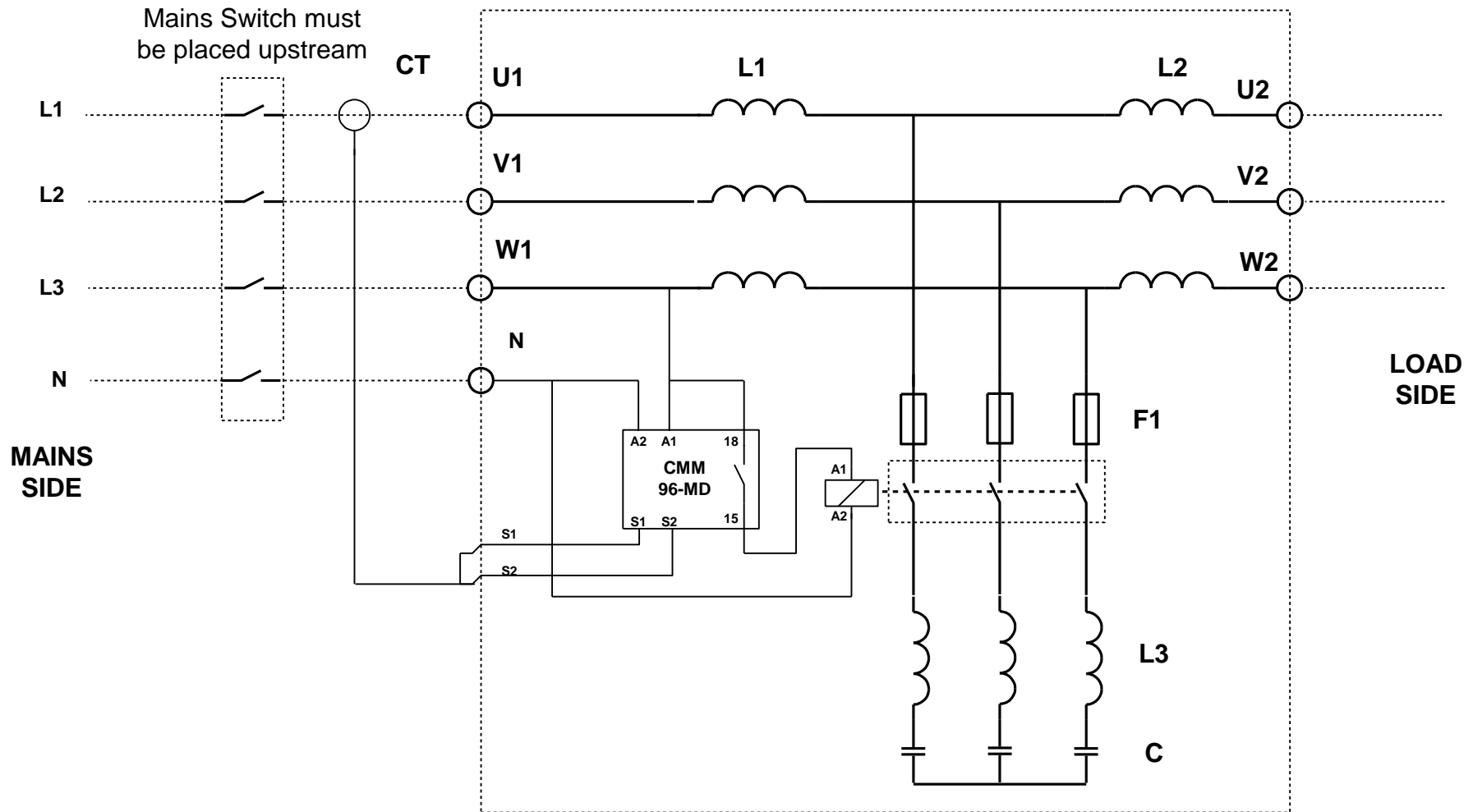

Fig. 3.- Schematic drawing

5 INSTALLATION AND START-UP.



5.1 LOCATION

The equipment must be located indoors, away from heat sources and adequately ventilated.

5.2 INITIAL CHECKS (pre-installation, switch the power OFF).



- A main switch must be provided upstream to cut the supply of the filter.
- Check that the nominal voltage of the equipment, shown on the technical information label is the same as the nominal voltage between phases for the system to which it will be connected.
- Connect the protective conductor: the cabinet must be earthed through the earthing terminal.
- Check and tighten terminals that may have come loose during delivery.

5.3 POWER CIRCUIT CONNECTION

- Connect the power terminals (U1, V1, W1) to input cables coming from the mains side and (U2, V2, W2) to the cables going to the converter side (Figure 3).
- **WARNING!** If holes need to be drilled in the casing to feed cables through, take care to avoid shavings falling onto the contactors.

5.4 OPERATING CIRCUIT CONNECTION (Only in case of overcompensation protection)

- The current transformer is installed at a point upstream of the filter. Usually in L1 incoming line.
- Connect the CMM-96-MD and set the device to the desired limit of reactive current. (See CMM-96-MD manual)

5.5 START-UP



- Check again the control and power circuit connections.
- Switch the main switch ON

6 CHECK POINTS

For optimum operation of the filter, the following points must be considered:

- **Voltage:** The operating voltage must not exceed the nominal voltage; Operating in overload conditions considerably reduces the life of the capacitors.
- **Current:** The absorbed current for each capacitor, must not exceed 1.3 times its nominal current.
- Whenever the current absorbed by the capacitors is higher than the nominal current may be due to excess of harmonics or a voltage higher than the nominal voltage. Both situations are harmful for the capacitors.
- In this event, the bank must be disconnected and **INTERNATIONAL CAPACITOR**'s technical department must be contacted to ascertain the best way to solve the problem.

7 PERIODICAL SERVICING

Maintenance should be carried out in accordance to the safety procedures detailed in section 8. HPF filters require minimal maintenance, but it is recommended that the following procedures be undertaken:

During the first month of operation.

- Visually inspect the capacitors.
- Examine the protective fuses.
- Control the temperature.
- Control the service voltage (especially under low load conditions).
- Retighten terminals and connections.

Annually.

- Check the capacitor's nominal current.
- Clean the terminals and isolators on the capacitors.
- Check that the terminal connections are tightened.
- Check the condition of the contacts on the contactor if there is overcompensation protection.

8 SAFETY

Before handling any device in the filter disconnect the supply upstream. The filter does not have any main switch. Switch must be placed at the line head.

Even when the bank is disconnected, there still may be voltage in the capacitors. Therefore, after having removed the supply voltage, wait for 3 minutes and then short circuit them and earth the terminals or output cables on each capacitor.

9 TECHNICAL SERVICE AND GUARANTEE

INTERNATIONAL CAPACITOR guarantees its products against manufacturing faults for one year from the date of delivery. The guarantee does not cover protective devices (fuses) nor operating devices subject to natural wear and tear.

This guarantee becomes void in the event of improper handling or disregard of the handling conditions.

INTERNATIONAL CAPACITOR has its CONSULTANCY AND TECHNICAL ASSISTANCE service at your disposal.

INTERNATIONAL CAPACITORS S.A

C/ Vallès, 32 – Polígono Industrial Can Bernades
08130 Santa Perpètua de Mogoda (Barcelona) SPAIN
Tel: (+34) 935 747 017 – Fax: (+34) 935 448 433